

20 YEARS of

ALTERA®

INNOVATION



SOPC

WORLD

2003



SOPC
WORLD
2003

StratixGX Design Guideline



SOPC
WORLD
2003

The Low-Risk Path to 3.125-Gbps Transceiver Applications

Bandwidth Demand

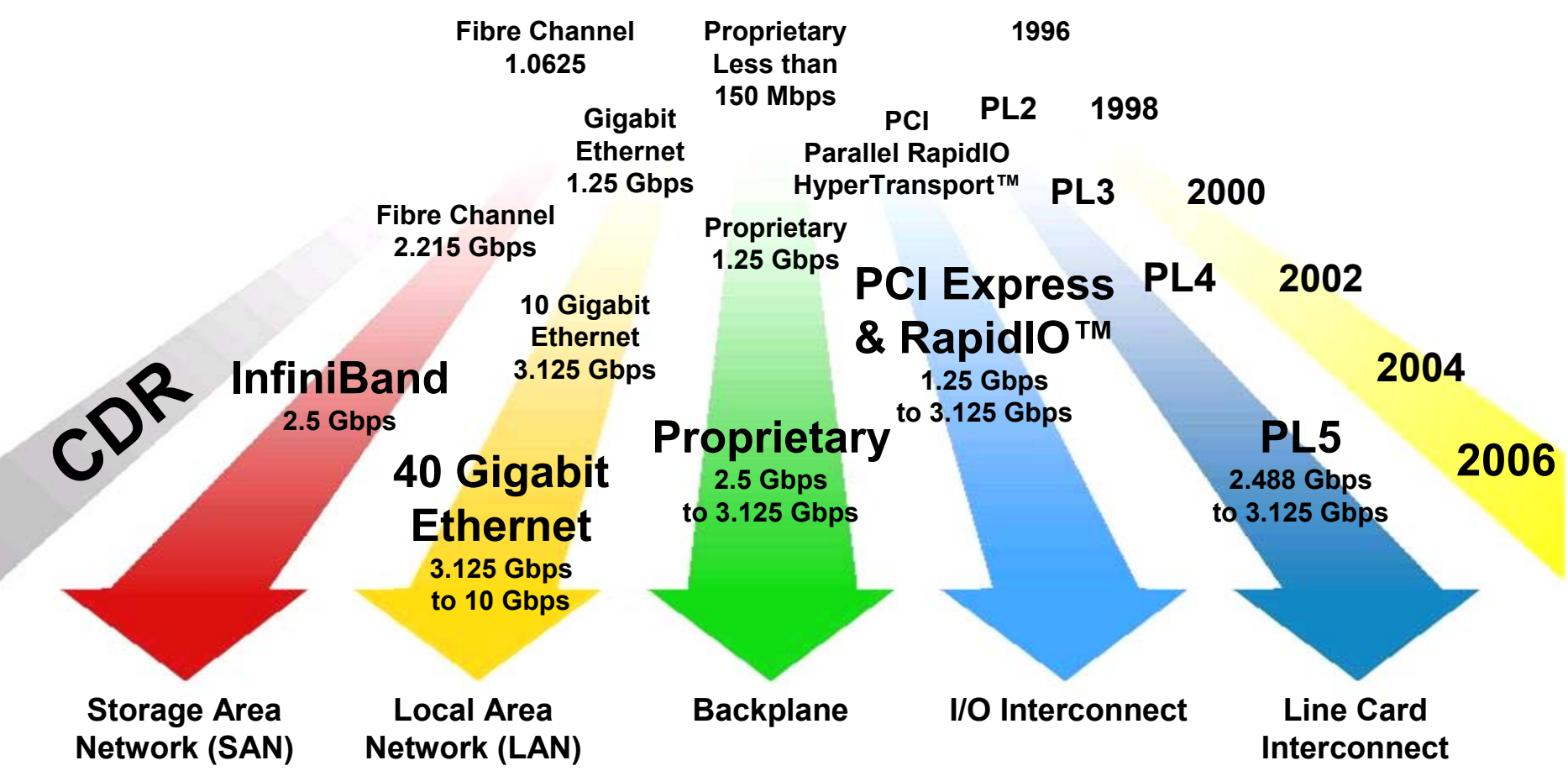

CDR

Benefits of Transceiver Integration



**Easy Interface
Protocol Bridging**

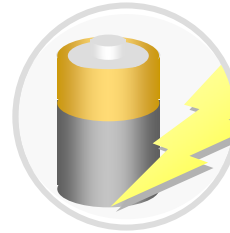

**Reduced Power
Consumption**

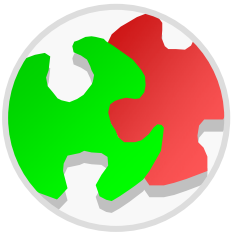

**Eliminated
Interoperability Issues**

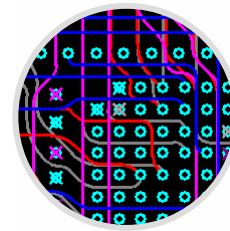

**Simplified PCB
Design & Real
Estate Savings**

***Integration Reduces Time-to-Market
& Lowers System Cost***

MJL



20 YEARS of
ALTERA
INNOVATION

Building on Experience

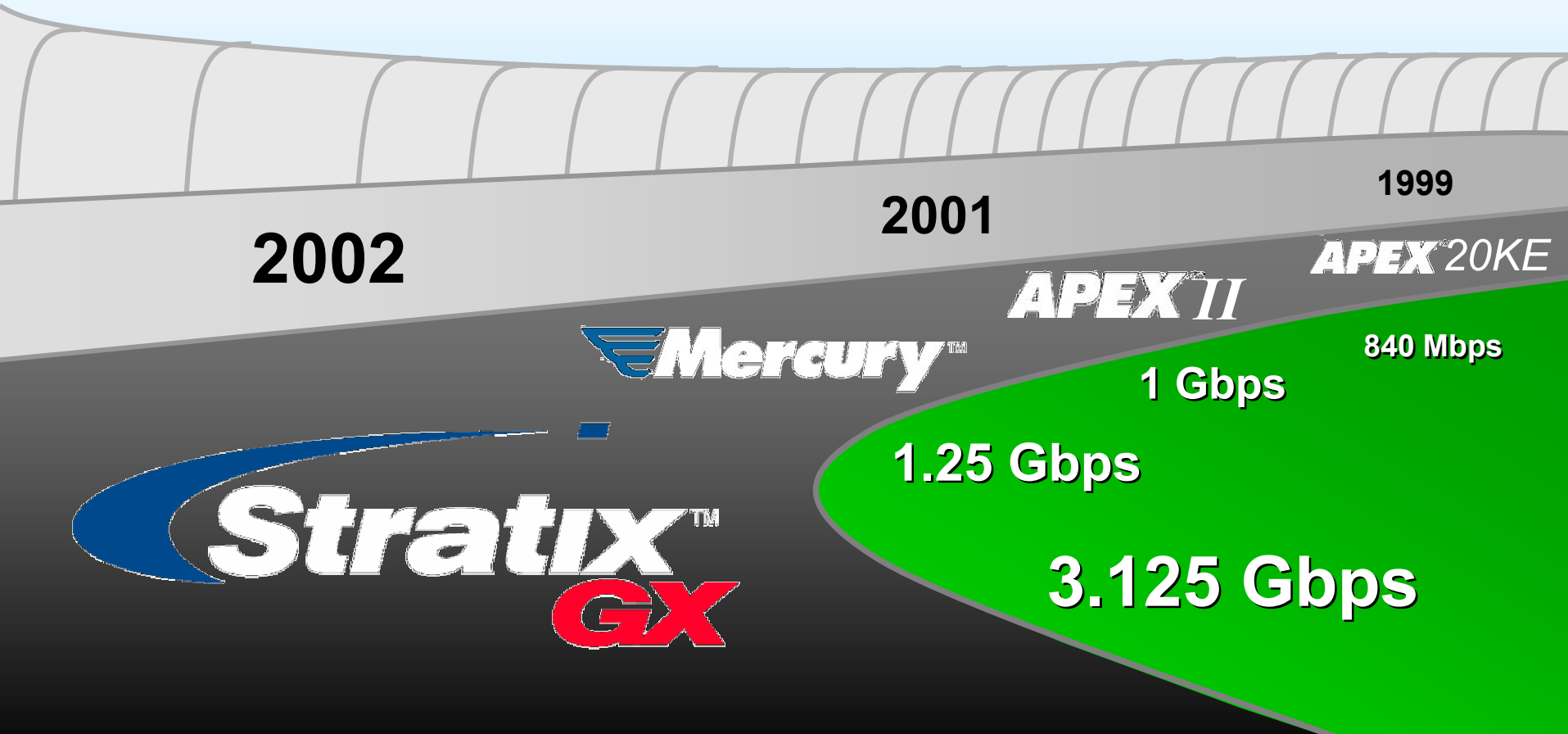
- Industry Leadership in High-Speed I/O Innovation & Expertise

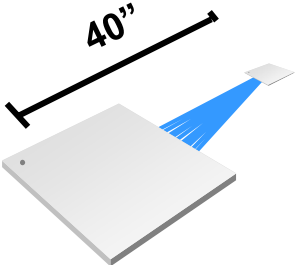
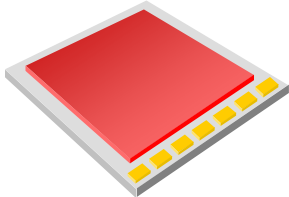
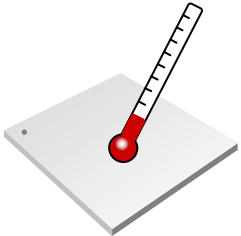

Experience Drives Success

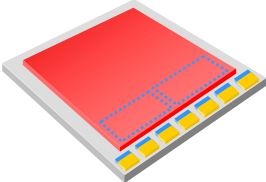
	Drive Capabilities Suitable for Data Transmission across Backplanes		Optimized Logic-to-Transceiver Channel Ratio & Channel Configuration
	Minimized Power Consumption in Both Transceiver & FPGA		Complete Soft IP Portfolio for Higher-Layer Function Implementation
	Balanced Data Throughput on Transceiver & Source-Synchronous Side		Implementation of Resource-Intensive Functions in Hard IP

Customer End-Product Delivery Is the Goal

MJL

20 YEARS of
ALTERA
INNOVATION

Stratix GX Device Family

Device	Logic Elements	Full-Duplex Transceiver Channels	Source-Synchronous Channels with DPA	Total Memory Bits	DSP Blocks
EP1SGX10C	10,570	4	22	920,448	6
EP1SGX10D	10,570	8	22	920,448	6
EP1SGX25C	25,660	4	39	1,944,576	10
EP1SGX25D	25,660	8	39	1,944,576	10
EP1SGX25F	25,660	16	39	1,944,576	10
EP1SGX40D	41,250	8	45	3,423,744	14
EP1SGX40G	41,250	20	45	3,423,744	14

***Supported in Quartus® II Software
Version 2.1 Today***

MJL

20 YEARS of
ALTERA
INNOVATION

Building on Stratix Architecture

Stratix (strät' ĭks) n. The industry's fastest FPGA device family offering unrivaled logic & memory resources

Transceiver (trän-se' vər) n. Clock data recovery-based data transmission technology supporting rates up to 3.125 Gbps

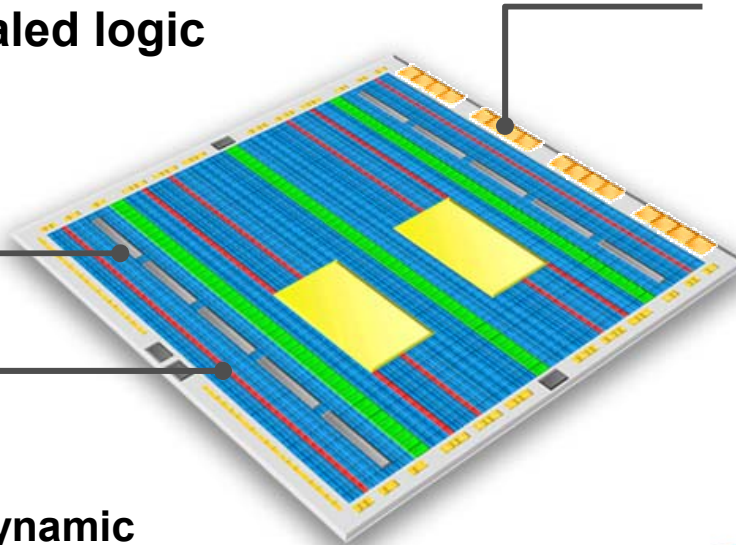

DPA (dē' pē ā) n. (dynamic phase alignment) Dedicated circuitry for resolving clock-to-channel and channel-to-channel skew, only found in Stratix GX devices

Stratix™
GX

MJL

20 YEARS of
ALTERA
INNOVATION

Gigabit Transceiver Block

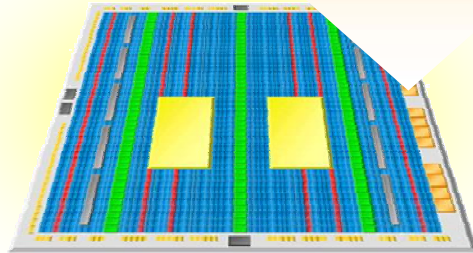
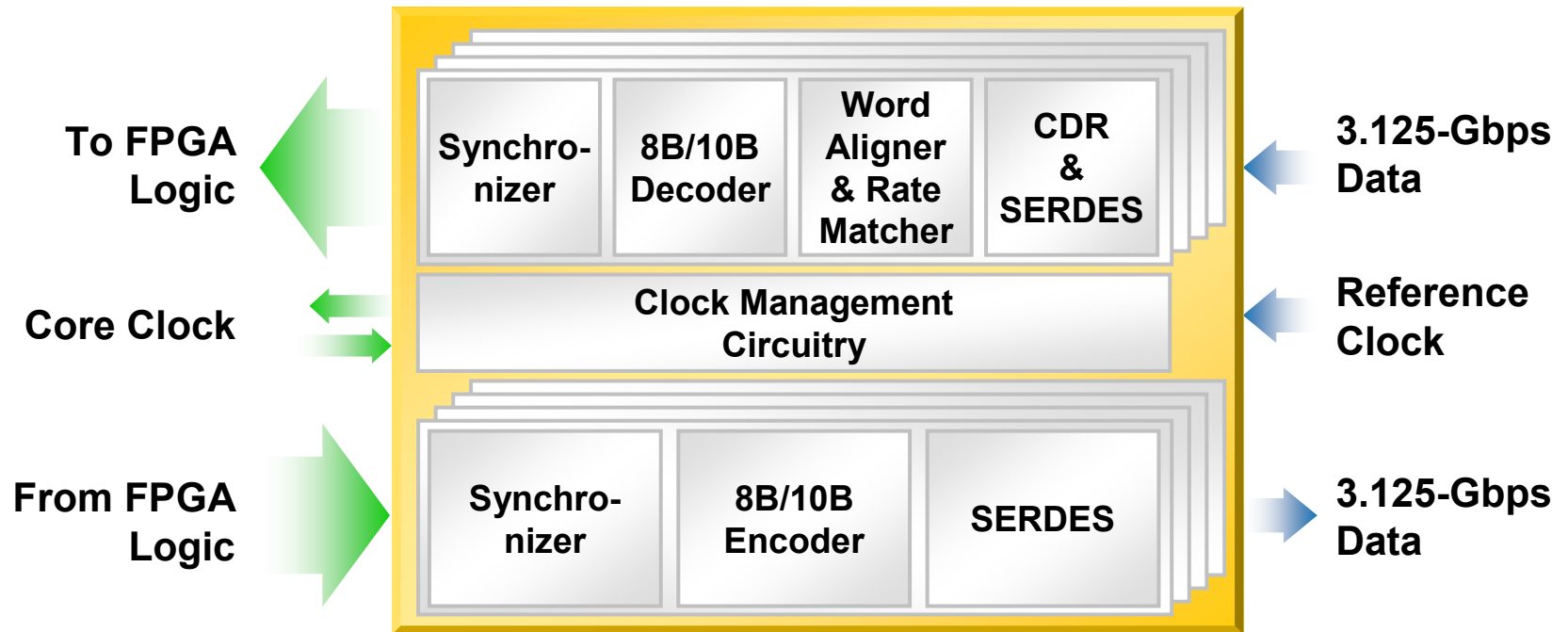

MJL

20 YEARS of
ALTERA
INNOVATION

Dynamic Phase Alignment

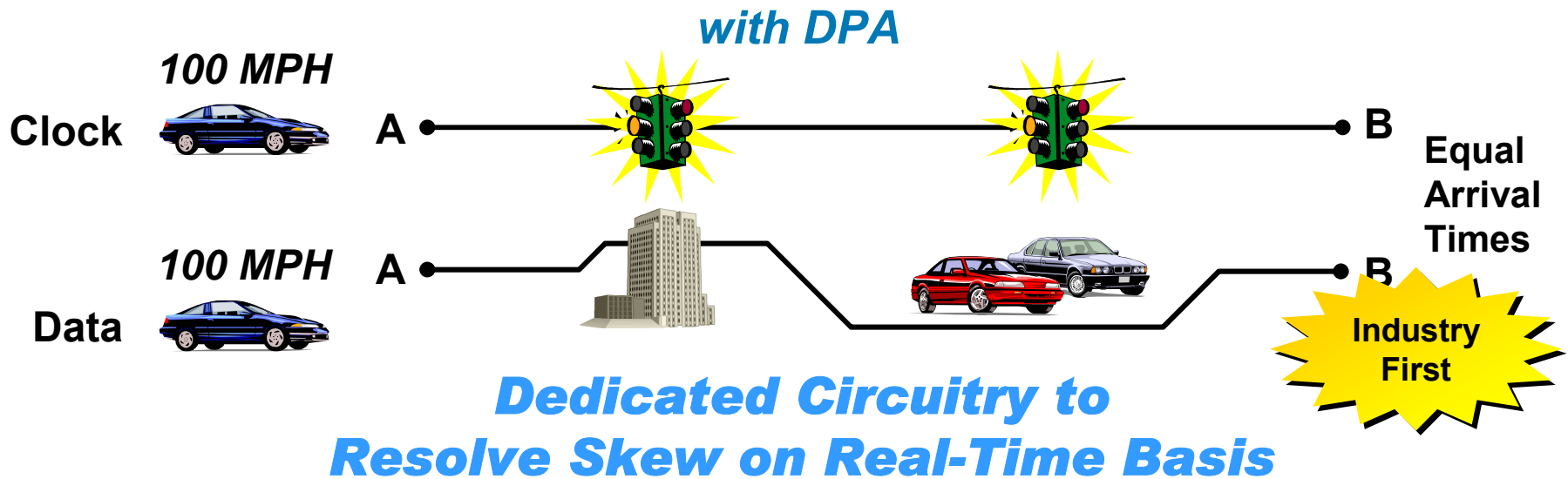
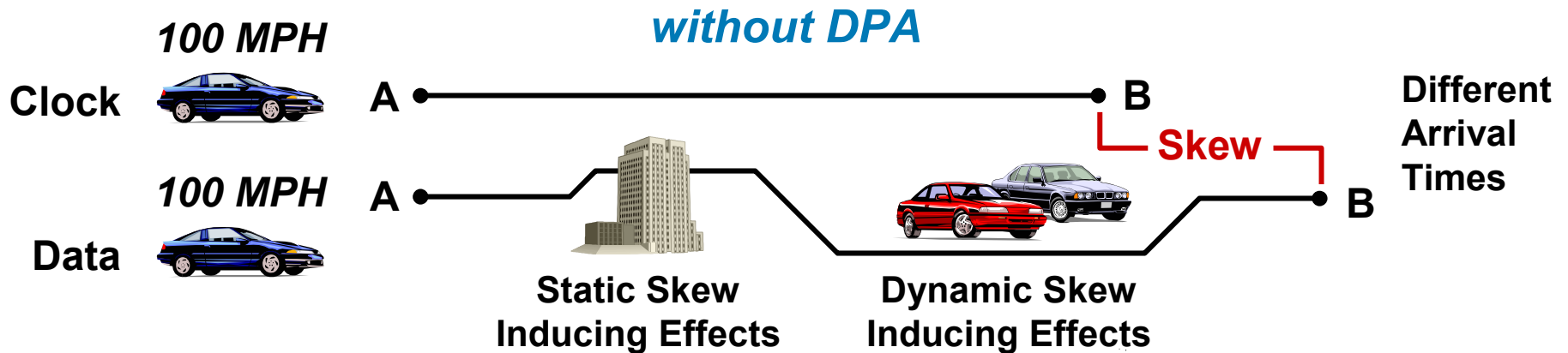

Hard DPA Advantages

- Ease of Implementation
 - Simplifies Complex Clock Management
- Conserves General-Purpose Resources
 - Logic, Global Clocks & PLLs
- Adjusts to Temperature & Voltage Changes

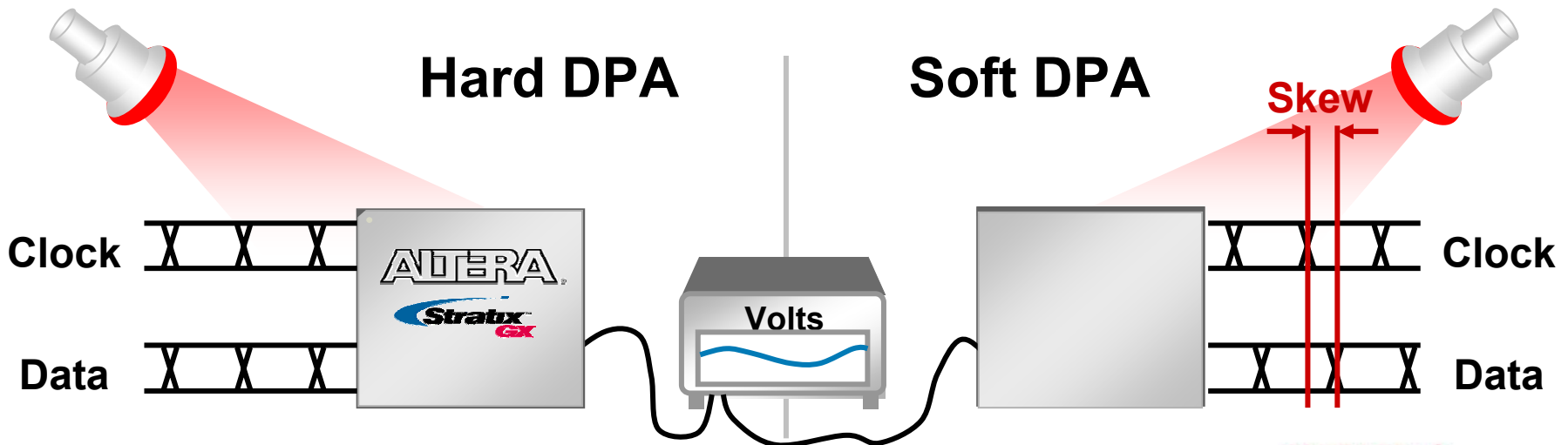

Stratix GX Applications Overview

Backplane Interfaces

- Traffic Management & QoS
- Backplane & Switch Fabric Transceiver

Chip-to-Chip Interfaces

- 10G Ethernet XAUI to XGMII Interface
- 10G Ethernet XAUI to POS-PHY 4 Bridge
- POS-PHY 4 to NPSI Bridge
- NPSI to Backplane Bridge

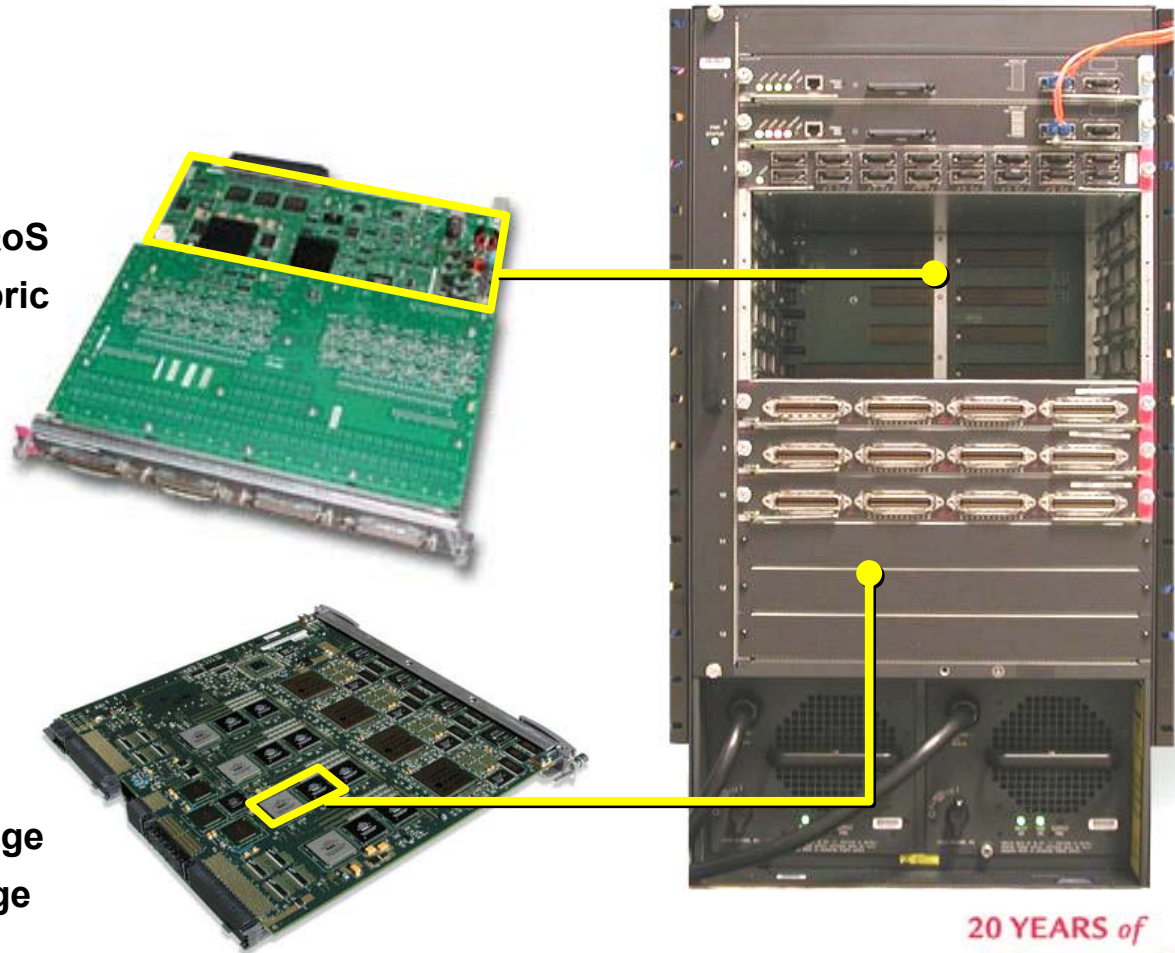

MJL

20 YEARS of
ALTERA
INNOVATION

Working 3.125-Gbps Silicon

Eye Diagram at Transmitter

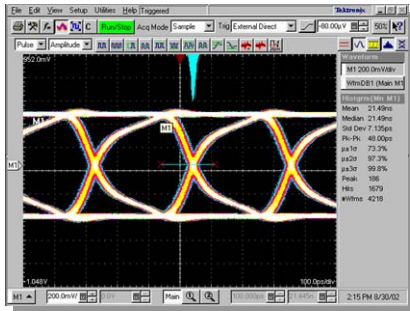

Conditions

- 3.125-Gbps Data Rate
- 40-Inch Trace Length
- PRBS 7 Data
- 0% Pre-Emphasis
- 85°C, VCC = 1.425 V
- Receiver Equalization
- Bit Error Rate of 10^{-12}

Eye Diagram at Receiver

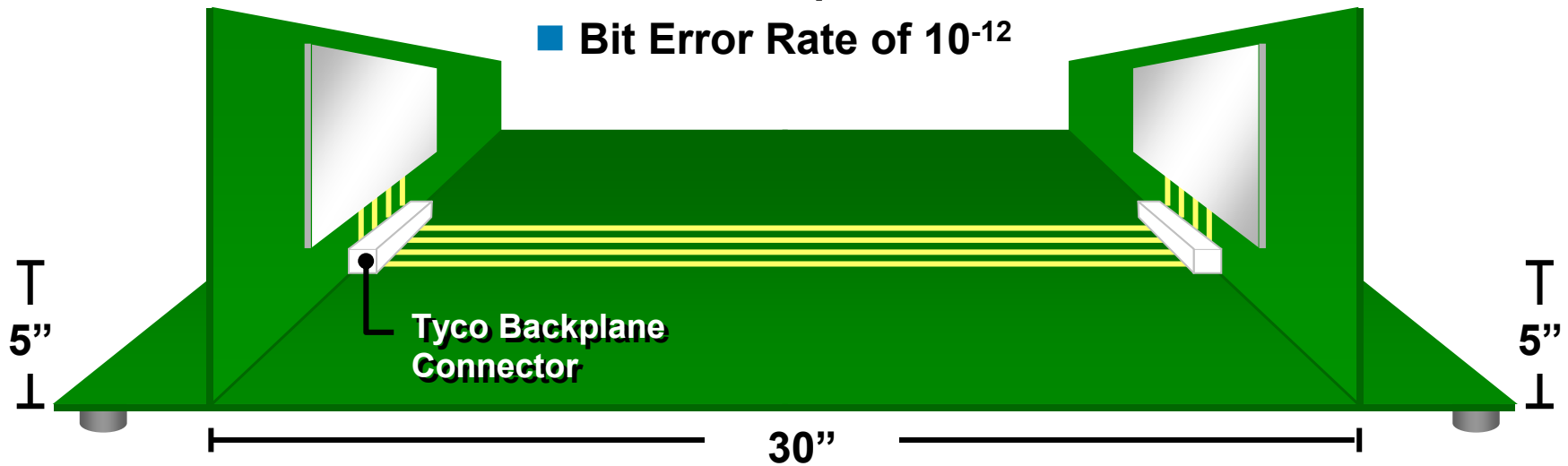
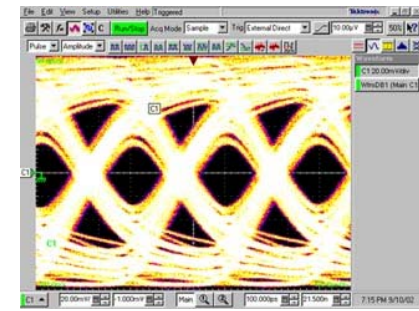

Stratix GX Highlights

- Second-Generation Product Reduces Customer Risk
 - Long Distance Drive Capability
 - Power-Efficient
 - Hard DPA Makes it Easy
 - Right Tools & Support
 - Right Hard & Soft IP
- Complete Set of Efficient Hard IP Functions
 - Significantly Reduces Resource Consumption





SOPC
WORLD
2003

Customer Engagement Plan

Stratix GX Update

- Stratix™ GX Silicon Characterization Exceeding Expectations
- Stratix GX Product Requires Much More than Silicon & Software
- Short-Term Factory Resources Prioritizing Product Completion
- Factory Resources Also Prioritizing Complete Protocol Support Packages

DPA & Source Synch TX

- X8 DPA Loopback Operates beyond 1 Gbps
- TX Output Eye-Pattern at 1 Gbps
- Preliminary Analysis Positive, Characterization Effort Is Ongoing

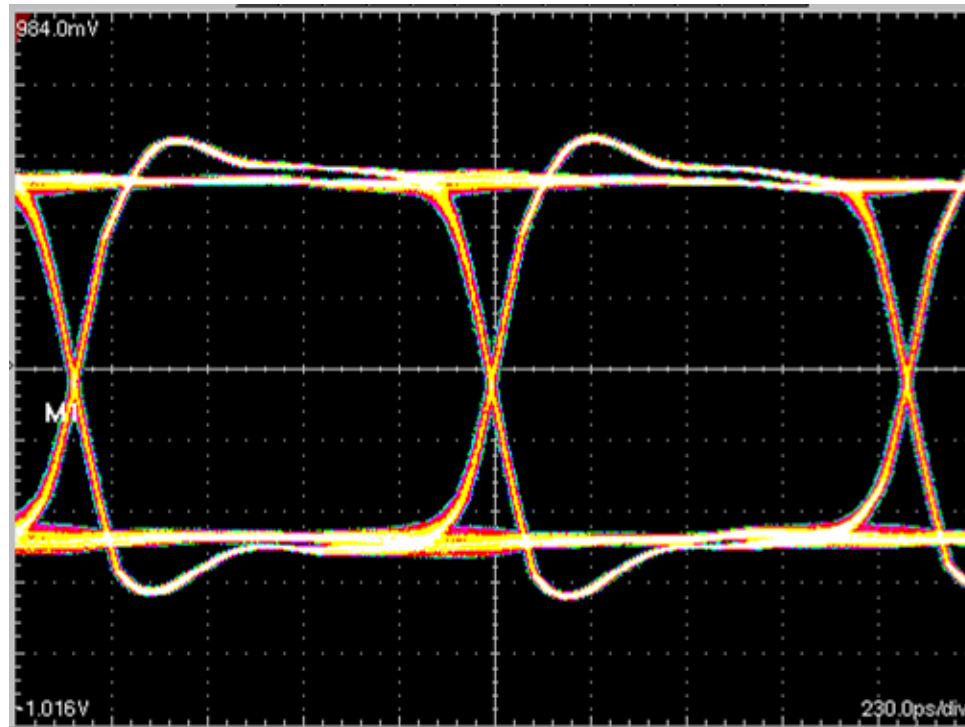

Transceiver Transmitter

- Output Eye Pattern at 3.125 Gbps
- Output Voltage = 1 Volt

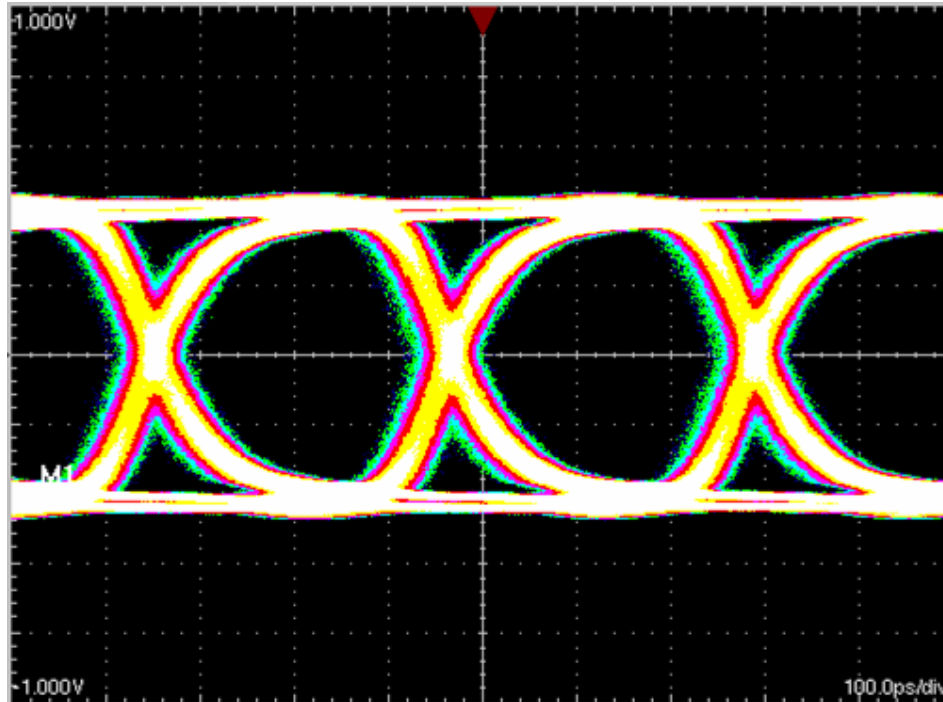

Signal through 40" Backplane

- Transceiver Output Eye-Pattern at 3.125 Gbps
- Output Voltage = 1 Volt

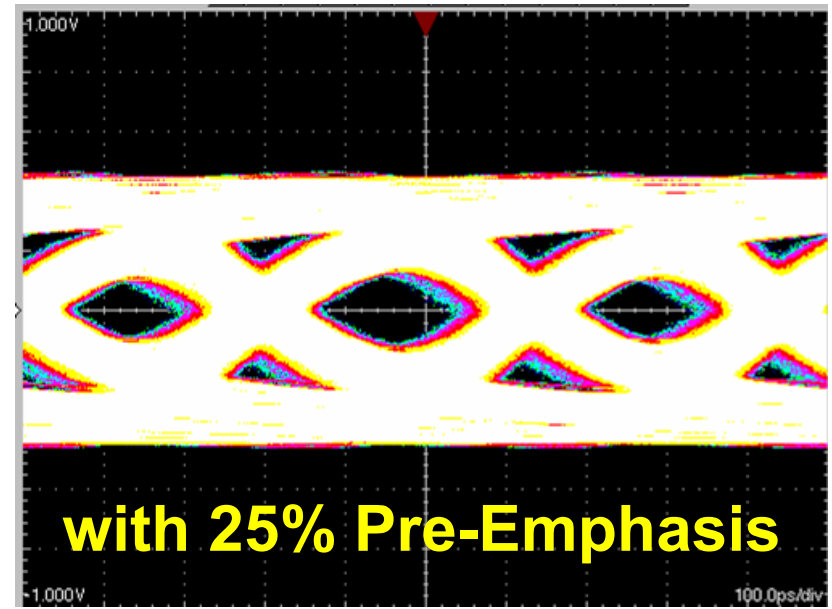
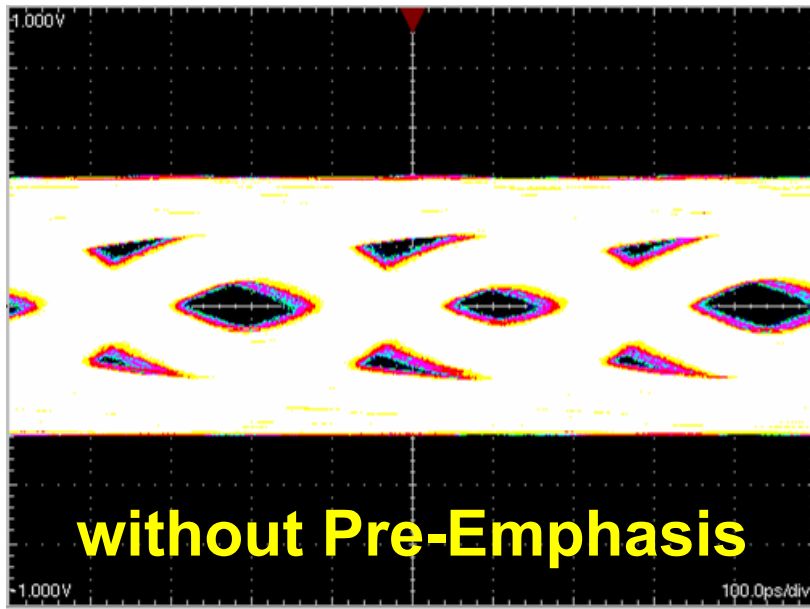

Stratix GX Whole Product

Stratix GX Whole-Product Components

Working Stratix GX Silicon

Advanced Quartus® II Design Support

Spice Simulation Package

Device-Level Characterization & Documentation

Development Platform

Protocol Characterization & Documentation

IP Cores & Reference Designs

App Notes & Board Design Guidelines

Interoperability Testing

Backplane Characterization

Product Completion Top Priority for 1H-03

MJL

20 YEARS of
ALTERA
INNOVATION

Development Platform

- Development Board
- Board Layout Guidelines
- Reference Designs
- Gerber Files
- Spice Models
- Software Support
- Much More . . .

Development Platform

Dramatically Improves Ease of Design

MJL

20 YEARS of
ALTERA
INNOVATION

Protocol Prioritization

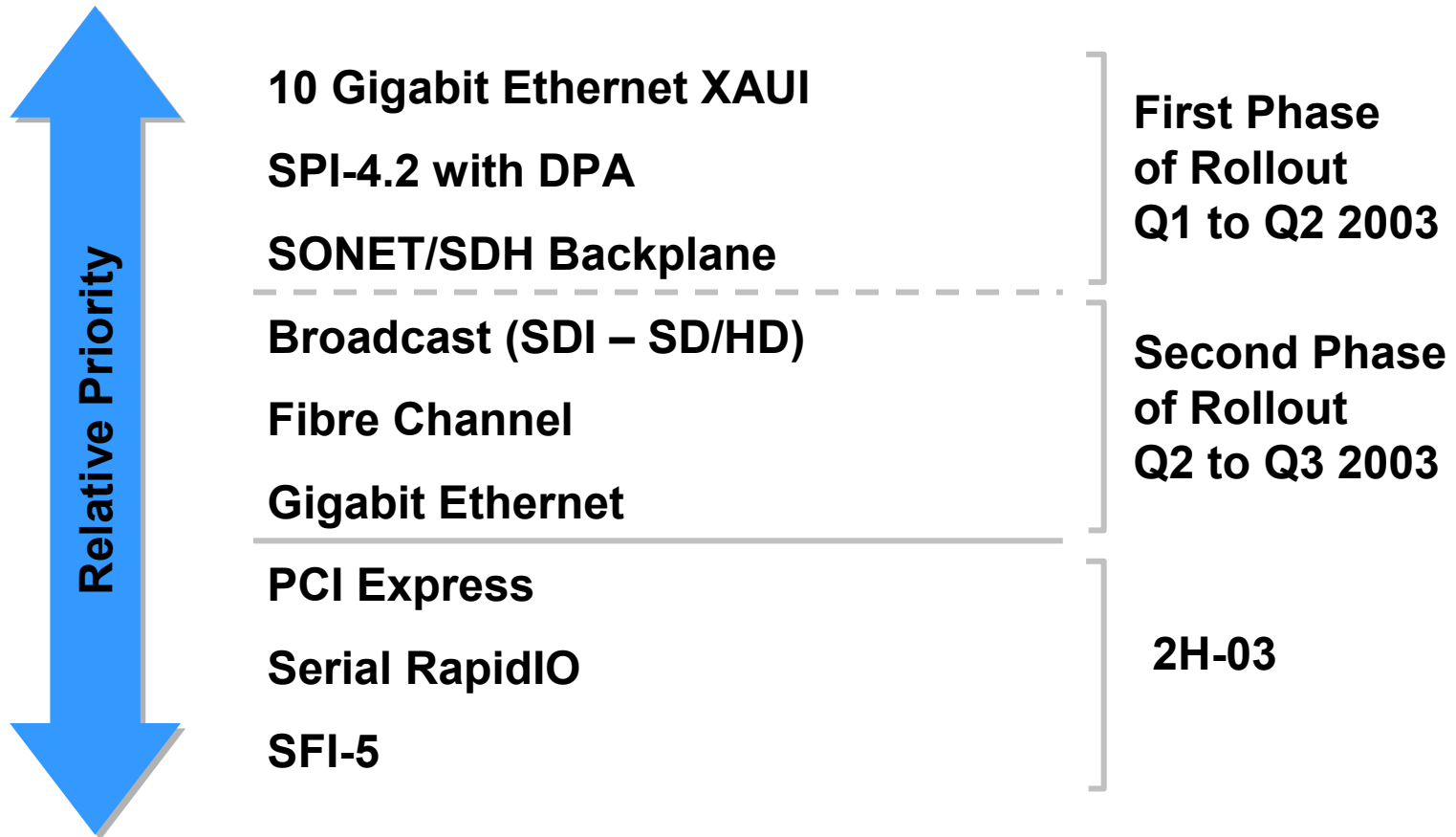

Stratix GX Deliverable Schedule

Deliverable	Date
Stratix GX Test Chip Characterization Report	January 2003
Stratix GX Characterization Plan	January 2003
Stratix GX Characterization Regular Updates	January 2003
Stratix GX HSSI Spice Models	February 2003
Stratix GX Development Board Functional Spec	February 2003
Quartus II Compilation Support (No Pinouts)	March 2003
Stratix GX DPA Spice Models	March 2003
Stratix GX Development Platform (\$20K)	June 2003
Full Support in Quartus II Version 3.0	June 2003

Early Adopter Engagement Plan

- Customer / Field Completes Detailed Questionnaire
 - Assess Customer Design Capability & Application (Protocol)
- Altera & Customer Decide if Opportunity Aligns with Stratix GX Schedule & Altera Support Capability
- Service-Level Disclosure with Customer
- Share Deliverables with Customers

Service-Level Disclosure

- Outlines Nature of Engagement with Customer
 - Altera Commits to Providing Customer with Silicon, Support & Technical Details
 - Customer Must Sign Non-Disclosure Agreement
 - Customer Agrees to Accept Staged Information & Silicon Release
 - Disclosure Clarifies Schedules on Remaining Device & Protocol-Characterization Effort & Collateral Plan

Engagement Guidelines

- Customer Requirements to Start Engagement
 - Sign Non-Disclosure Agreement
 - Complete Questionnaire
 - Commit to Purchase a Stratix GX Development Platform
 - Agree to Provide Feedback on Evaluation Stratix GX Results

20 YEARS of

ALTERA®

INNOVATION



SOPC

WORLD

2003